

# Owners Manual

TEC ELECTRONIC CASH REGISTER

## MA-132 SERIES

U.S.A. & CANADA VERSION

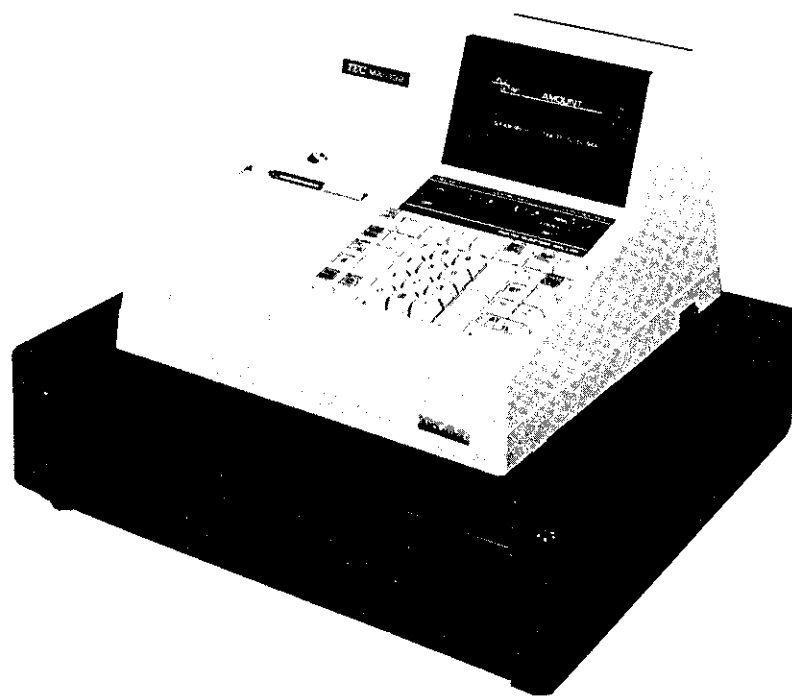

**TEC** TOKYO ELECTRIC CO.,LTD.

**WARNING**

This equipment generates, uses, and can radiate radio frequency energy and if not installed and used in accordance with the instructions manual, may cause interference to radio communications. It has been tested and found to comply with the limits for a Class A computing device pursuant to Subpart J of Part 15 of FCC Rules, which are designed to provide reasonable protection against such interference when operated in a commercial environment. Operation of this equipment in a residential area is likely to cause interference in which cause the user at his own expense will required to take whatever measures may be required to correct the interference.

## TABLE OF CONTENTS

	(page)
TO OUR CUSTOMERS .....	1
PRECAUTIONS .....	1
APPEARANCE AND NOMENCLATURE .....	1
CONTROL LOCKS AND MODE SELECTOR KEYS .....	2
DISPLAY .....	3
KEYBOARD LAYOUT .....	4
FUNCTION OF EACH KEY .....	6
REGISTERING PROCEDURE FOR SALES .....	15
REGISTERING RECEIPT SAMPLES .....	21
VALIDATION PRINT SAMPLES .....	25
READ(X) AND RESET(Z) REPORTS .....	26
PROGRAMMING OF THE REGISTER .....	29
PROGRAM VERIFICATION .....	41
PAPER ROLL REPLACEMENT AND OTHER MAINTENANCE .....	43
SPECIFICATIONS .....	46



## TO OUR CUSTOMERS

Thank you for choosing a TEC electronic cash register MA-132 series. This instruction manual provides a description of the functions and handling of this register and should be read carefully to obtain maximum performance. Since every consideration has been given to safety, there is no danger of damaging the machine by incorrect operation.

Please refer to this manual whenever you have any doubts concerning the machine. This machine has been manufactured under strict quality control and should give you full satisfaction. However, if the machine is damaged during transit, or there are any unclear points in this manual, please contact your local TEC representative.

- The specifications described in this manual may be modified by TEC, if necessary.
- Be sure to keep this manual for future reference.

## PRECAUTIONS

1. The keys on the keyboard work with a light touch. Avoid pressing the keys too hard.
2. Avoid handling the machine with wet hands.
3. Do not apply thinner or other volatile oils to the cabinet or other plastic parts. If dirty, wipe off with a piece of cloth soaked in neutral detergent and squeezed tightly.

## APPEARANCE AND NOMENCLATURE

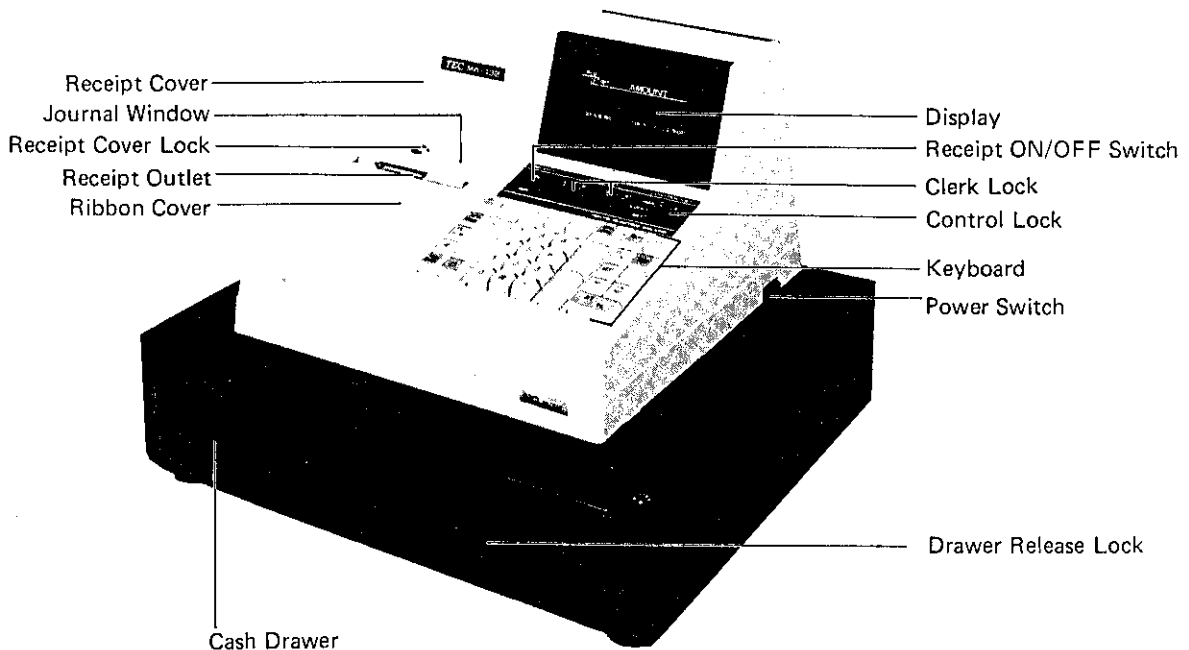

- **Power Switch** ... The Power Switch is provided at the righthand side of the cabinet. The AC power is turned on when the switch is pushed to ON, and turned off when the switch is pushed to OFF.

# CONTROL LOCKS AND MODE SELECTOR KEYS

CONTROL LOCK

(POSITION)

(FUNCTION)

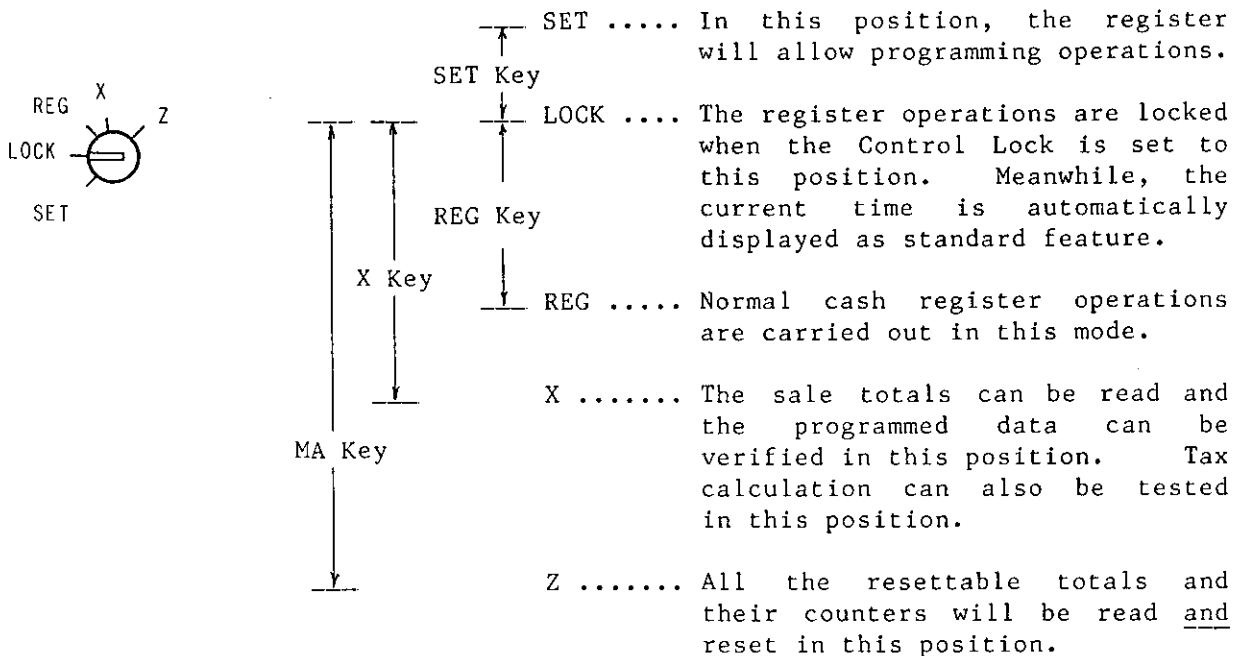

## Mode Selector Keys for Control Lock

- REG Key:** The REG Key is used by the cashier who operates the register. This key can access the positions of LOCK and REG.
- X Key:** The X Key is used by the store manager or a person authorized to read the sales totals during the day by the store manager. This key can access the positions of LOCK, REG, and X.
- MA Key:** The MA Key is used by the store manager who will daily supervise the collection of money and the printing of transactions recorded by the register. This key can access the positions of LOCK, REG, X, and Z.
- SET Key:** The SET Key is used by the programmer. This key can access the positions of LOCK and SET.

All the keys can be removed at the "LOCK" or "REG" position.

## CLERK LOCKS

These locks are used to identify which clerk or cashier is operating the register.

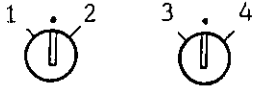

Clerk Keys (1, 2, 3, 4)

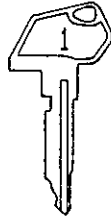

Each cashier should keep his/her clerk key. The register will not operate in any position of the Control Lock unless one of these keys is inserted and set to the corresponding position on the Clerk Locks. Each of the keys may be inserted and pulled out in the neutral position marked with "." (point).

## DISPLAY

The front display is located at the top of the register just above the keyboard.

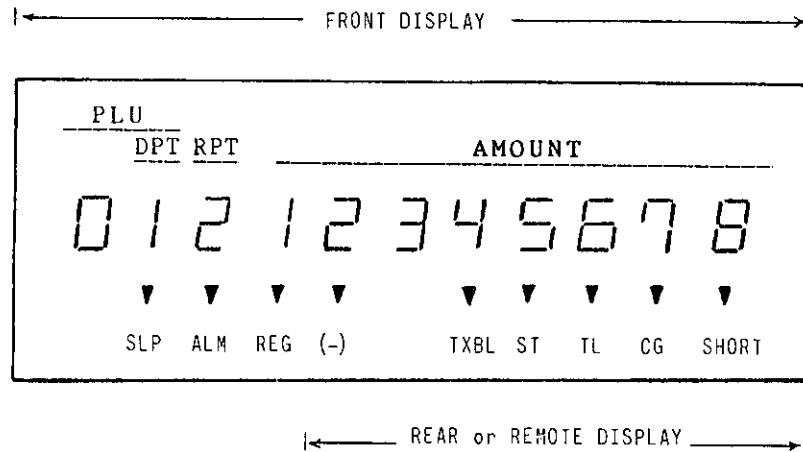

### NUMERIC DISPLAY

- AMOUNT (8 digits): Displays the numeric data, such as amount, quantity, etc.
- RPT (1 digit): Displays the repeat count of a Department or PLU item. It indicates nothing on the first item entry, showing 2, 3, 4, etc. from the second repeated item entry on. Since it has only one digit, 0 will be displayed for count 10, and 1 for 11, etc.
- DPT (1 digit): Displays the code No. which represents each Department Key.
- PLU (2 digits; one digit commonly used with the DPT digit):  
Displays the PLU code No. when a PLU item is entered.

## MESSAGE DESCRIPTORS (TRI-MARKS to appear)





- ▼ SLP: Appears when a validation slip has been properly inserted to allow validation.
- ▼ ALM: Appears with the alarm buzzer to indicate that the last operation or numeric entry has resulted in an error. To clear the error condition, depress the **C** key.
- ▼ REG: Appears when sale items have been entered.
- ▼ (-): Appears when the **RTN MDSE**, **DOLL DISC**, **%-**, or **ITEM CORR** key has been operated. It also appears when the **ST**, **TXBL TL**, or one of the total keys have been depressed and the displayed amount is negative.
- ▼ TXBL: Appears when a taxable item is entered or the **TXBL TL** key is depressed.
- ▼ ST: Appears when the sub-total amount is displayed after the **ST** key has been depressed. Also appears when the **TXBL TL** key has been depressed.
- ▼ TL: Appears on a finalizing operation with the total amount displayed when a sale is finalized without any amount tendered.
- ▼ CG: When an amount tendering operation has been performed, this tri-mark appears with the change due displayed.
- ▼ SHORT: Appears when the amount tendered is less than the sale total with the shortage amount displayed.

## KEYBOARD LAYOUT

The following are the Standard Keyboard Layout and two other variations of the MA-132 series, according to the tax requirements for different areas. Since this series is designed to be capable of programming many of the keys in the most desired location on the keyboard, please contact your TEC representative if any key is to change its location with another.



STANDARD KEYBOARD  
(for a single-tax area)

RECEIPT			
ON  OFF			

VALI DATE	NS	RF	JF	RCPT ISSUE	DOLL DISC	%-	%+
RTN MDSE	X	7	8	9		R/A	PO
TX/M	PLU	4	5	6	1	ST	Chg
#		1	2	3		TXBL TL	CHK TEND
ITEM CORR	C	0	00	.	2	AT/TL	

TYPICAL KEYBOARD FOR A DUAL-TAX AREA  
(Two Tax Modifier Keys Installed)

VALI DATE	#/NS	RF	JF	RCPT ISSUE	DOLL DISC	%-	%+
RTN MDSE	X	7	8	9		R/A	PO
TX1/M	PLU	4	5	6	1	ST	Chg
TX2/M		1	2	3		TXBL TL	CHK TEND
ITEM CORR	C	0	00	.	2	AT/TL	

TYPICAL KEYBOARD FOR SINGLE-TAX AREA WITH MANUAL TAX ENTRY REQUIRED  
(One Tax Modifier Key and Manual Tax Key Installed)

VALI DATE	#/NS	RF	JF	RCPT ISSUE	DOLL DISC	%-	%+
RTN MDSE	X	7	8	9		R/A	PO
TX/M	PLU	4	5	6	1	ST	Chg
TAX		1	2	3		TXBL TL	CHK TEND
ITEM CORR	C	0	00	.	2	AT/TL	

## FUNCTION OF EACH KEY

### ON RECEIPT ON/OFF SWITCH



This switch has two positions available: "OFF" and "ON" positions. When in the "OFF" position, no receipt is issued from the register and sales are printed on the journal only. When the switch is set to the "ON" position, sales are printed on both receipt and journal rolls, then a receipt is issued which is cut and given to the customer.

Alternating the switch position during a registration will not result in an error. In this case, the position set at the registration starting will rule whether a receipt is issued or not. When a reset (Z) report is taken, however, the data will be printed also on the receipt roll regardless of the switch position.



### VALIDATION KEY

This key is used to print a validation slip.

To operate, insert a slip into the validation slot after registering the required item, and depress the **VALIDATE** key. The item and the amount will be printed on the slip.

The system option provides program selections as to single- or multi-validation and consecutive No. print or non-print on the validation slip.



NS

### NO-SALE KEY

This key is used to open the cash drawer while the register is outside a sale in such occasions as giving change without relating to a sale. To operate, depress the **NS** key once. This key may also be operated to check the print condition on the receipt and journal.

Usually, a non-add number cannot be entered prior to a no-sale operation within a receipt. However, it can be programmed to allow a non-add number entry when a no-sale is operated.



RF

### RECEIPT FEED KEY

This key is used to advance the receipt roll. It is operated by depressing the key and holding it in that position until the paper has advanced to the required position.

This key can be operated in any position of the Control Lock including the "LOCK" position.

JF

#### JOURNAL FEED KEY

This key is used to advance the journal roll in the same way as the RF key. This key is useful if the cashier, due perhaps to an interruption whilst ringing up a sale, is unsure which items have already been entered. By using this key, the cashier can see which items have actually been printed.

RCPT  
ISSUE

#### RECEIPT POST-ISSUE KEY

This key is used to issue the receipt of a sale which has already been finalized with the RECEIPT ON/OFF SWITCH positioned to OFF.

To operate, depress the **RCPT ISSUE** key without a numeric entry. The receipt for the last sale is then issued, with only the sale total printed but not details. This key will not function if another sale has already been under way on the register. The receipt post-issue operation is not possible after a Received on Account or Paid Out transactions.

DOLL  
DISC

#### DOLLAR DISCOUNT KEY

This key is used to subtract an amount from the sale total such as a discounting a sale. This key cannot normally be used outside a sale. Neither can an amount exceeding sale total normally be entered. However, when the "Credit Balance" option has been selected, this key can be used inside or outside a sale and over-subtraction of the sale is allowed.

This key can be programmed with taxable or non-taxable status. When the tax status of this key must be reversed, depress **TX/M** (or **TX1/M** and/or **TX2/M** in a dual-tax area) before this key is depressed.

To operate, enter the discount amount on the numeric keyboard, and then depress this key.

%-

#### PERCENT DISCOUNT KEY

This key is used to subtract a percentage rate from the sale or an item. If the preset rate is to be subtracted, depress this key without a prior rate entry. If a rate different from the preset one is required, enter the desired rate on the numeric keyboard and then depress this key. The manual rate will take priority.

To operate, depress the **%-** key either immediately after a department or PLU entry if only that item requires the percent discount, or after the **ST** key has been depressed if required from the total bill. The percent rate and the discount amount calculated are printed and subtracted from the sale total.

The percentage rate may be entered within the range from 0.01% to 99.99%. The fraction resulted from the percentage calculation is usually programmed to be rounded off. However, it can be programmed to be rounded up or rounded down.

Usually, **%-** key may operate only once after obtaining a sub-total. However, it can be programmed to allow any number of times.

Just like the DOLL DISC key, this key is also programmed with taxable or non-taxable status. Use TX/M (or TX1/M and/or TX2/M in a dual-tax area) before operate the %- key if the preset tax status of the %- key must be reversed.

%+

#### PERCENT CHARGE KEY

This key operates in the same way as the %- key except that operation will add to instead of subtracting from a sale.

RTN  
MDSE

#### RETURNED MERCHANDISE KEY

This key is used to make a subtracting entry for a returned item. This key is also used to invalidate an item entered before the last entry within a sale, in which case the ITEM CORR key cannot invalidate the designated item.

To operate, depress this key before or after the amount entry, and depress the department key from which the amount is subtracted. This key may be operated during a PLU item entry sequence (if before the PLU key) to process the returned amount into the PLU memory.

TX/M

(for a single-tax area)

#### TAX MODIFIER KEY(S)

TX1/M

TX2/M (for a dual-tax area)

These keys are used to reverse the taxable/non-taxable status on departments, PLUs, DOLL DISC, %-, or %+ key for one entry only. However, in a repeat entry by depressing the PLU or the same department key again, the reversed tax status will be held for those repeated items.

For dual-tax areas, two keys are provided -- TX1/M and TX2/M -- in place of the TX/M key for single-tax areas. The two tax modifier keys will function independently each with its own tax table pre-programmed for taxable items.

To operate, depress the Tax Modifier Key(s) prior to depressing any of the above mentioned keys (i.e., before or after the amount entry).

#

#### NON-ADD NUMBER PRINT KEY

This key is used to print a non-add number (such as Customer No., Check No., Credit Card No., etc.) on the receipt and journal for future reference.

To operate, enter a maximum of 8-digit number and then depress this key. The number is then printed. This operation may be performed any time between items, before or after all the sale items.

**ITEM  
CORR**

**ITEM CORRECT KEY**

This key is used to delete the last item within a transaction. Depressing this key once will remove the last line item from the bill, printing a line through the item on the receipt and journal.

The item-correct function is effective even when a numeric entry and a **C** key depression are performed between the item entry to be corrected and the **ITEM CORR** key depression. However, if any other key-in operation including an error comes inbetween, the item-correct will not function.

The **ITEM CORR** key may function to correct any last item entered through a department, a PLU, the **%-**; **%+**, **DOLL DISC**, **R/A**, **PO**, or **TAX** key. But a returned department or PLU item cannot be item-corrected.

**X**

**QUANTITY EXTENSION (MULTIPLICATION) KEY**

This key is used to multiply a department or PLU entry by a quantity.

The multiplication input order is programmed in either of the following two methods:

1) QUANTITY x PRICE (standard)

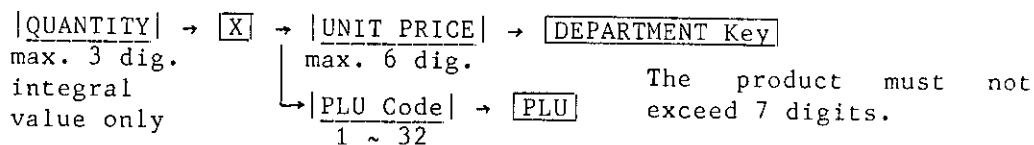

2) PRICE x QUANTITY (option)

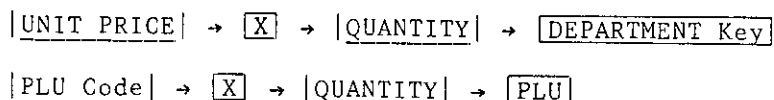

**PLU**

**PLU (Price-Look-Up) KEY**

This key is used to enter a PLU that is linked to a department. Each PLU is programmed with its code (1 to 32) and preset price. The tax status of each PLU is ruled by that of the linked department.

To operate, enter the PLU code and then depress the **PLU** key. The preset price is automatically read and entered into the department to which the PLU is linked. To repeat the same PLU price, depress the **PLU** key consecutively after the above operation.

As for quantity extension involving PLUs, refer to the **X** key description mentioned above. Also refer to the **RTN MDSE** key description on page 8 as to return entry through a PLU.

If a PLU's link Department Key is programmed as a Single-item Key, an entry through that PLU also functions as the single-item PLU. That is, that PLU can only be registered outside a sale and the sale will immediately be finalized as cash on the depression of the **PLU** key without operating a media key such as **AT/TL**.

C

CLEAR KEY

This key is used to correct a numeric entry error if prior to depressing any other function key, or to correct any error condition and cancel an alarm buzzer.

If this key is depressed before depressing the Department Key or **PLU** in a quantity extension sequence, all of the quantity entry, the **X** key depression, and the unit price entry are all cleared at a time.

If the **C** key is depressed after a sub-total is obtained, the sub-total is then displayed.

The **C** key may be operated regardless of the Control Lock positions except "LOCK".

#/NS

NON-ADD NUMBER PRINT / NO-SALE KEY

This key has both functions of **#** and **NS** keys that have already been described on page 8 and page 6 respectively. It functions as Non-add Number Print Key with a prior numeric entry, or as No-sale Key without a prior numeric entry. If this key is installed, the **#** and the **NS** keys must be eliminated from the keyboard.

LC  
OPEN

LISTING CAPACITY OPEN KEY (optional key)

This key is used to release the listing capacity preset on each Department key temporarily. To operate, depress this key before depressing the department key (either before or after the numeric entry).

By depressing the **LC OPEN** key, the listing capacity will be released to allow a numeric entry with two further digits. Repeat operations will be possible on a department key even when the **LC OPEN** key is used before the department key.

7 8 9  
4 5 6  
1 2 3  
0 00 .

NUMERIC KEYS

These are used to enter numeric values such as amount, quantity, and non-add number.

Depressing the **00** key once is the same as depressing the **0** key twice consecutively.

The **.** key is used to enter the decimal point of a manual percent rate containing decimal portion. The **.** key cannot be used for any other purpose.

The maximum listing capacity for sale item amount through a department or PLU is 7 digits. If a listing capacity is programmed for a department, any amount entry exceeding the listing capacity will result in an error.

The maximum listing capacity for a non-add number or amount tendering is 8 digits.

1
2

## DEPARTMENT KEYS

These are department keys through which sales items are registered. To operate, enter the amount of the item and depress the appropriate department key. A consecutive depression of the same department key will repeat the same amount entry, which can be repeated any number of times. The sale is not finalized after a department entry until a finalizing key (AT/TL, etc.) is operated.

As an option, Department 1 key can be programmed to be used as Single-item Department Key. In this case, the sale will immediately be finalized as cash after an amount entry and the key depression without the AT/TL key.

The maximum digits for a department entry is limited by the programmed listing capacity. If no specific listing capacity is set, a maximum of 7-digit amount can be entered.

Each department is programmed with taxable or non-taxable status. If reversing the tax status of a department is necessary, use the TX/M (for single-tax area) or TX1/M and/or TX2/M (for dual-tax areas). Refer to the description for the Tax Modifier Keys on page 8.

Also refer to the X key description on page 9, as to QUANTITY EXTENSION using department keys.

R/A
-----

## RECEIVED ON ACCOUNT KEY

A received-on-account transaction is used to identify money which is in the drawer but not business. The amount entered is thus included in the "Cash-in-drawer" total but not in the sales totals.

To operate, enter an amount of payment and then depress the R/A key. Repeat this operation if multiple payments are entered at a time. The payments thus entered may be finalized by AT/TL (for cash payments) or CHK TEND (for check payments). The Chg key may also function to finalize payments received on account if not prohibited in the system option. The above operation can only be done when the register is outside a sale.

The ITEM CORR key is effective to delete a payment just recorded with a depression of R/A, if before finalized by a media key.

PO
----

## PAID OUT KEY

A paid-out transaction is used when an amount of money is removed from the cash drawer without relating to a sale. When the PO key is used, the amount entered is subtracted from the "Cash-in-drawer" total but does not affect the sales totals.

To operate, enter an amount taken from the cash drawer and depress the PO key while the register is in an out-of-sale condition. This operation may be repeated if multiple paid-out items are registered at a time. The paid out amounts recorded are finalized by the AT/TL key only.

The **ITEM CORR** key is effective to delete a payment just recorded with a depression of the **PO** key, if before finalized by the **AT/TL** key.

**ST**

#### SUB-TOTAL KEY

This key is used to obtain the sub-total amount during a sale. When this key is depressed after all the items have been rung up, the sub-total of the sale without tax is printed and displayed.

If the **ST** key is depressed more than once consecutively, the first depression only will print and display the sub-total; further depressions will only display but not print the sub-total amount.

The system option provides the selection not to print but only display the sub-total even on the first depression of the **ST** key.

**TXBL  
TL**

#### TAXABLE TOTAL KEY

This key is used to obtain the contents of the sale total plus any taxes due. The amount will display only but not print.

In order to allow add-on operations to follow the use of this key, the taxes are not added into any totals until actual finalization is initiated.

Mandatory depression of this key prior to finalizing a sale is a programmable option.

**TAX**

#### MANUAL TAX KEY

This key is used to enter an irregular tax amount that cannot be calculated on the basis of the programmed tax table, and to add it to the sale total.

To operate, enter the desired amount of tax, and then depress the **TAX** key. The tax amount entered is then printed. This tax amount is processed into the TAX 2 memory. Therefore, the tax amount automatically calculated and printed at finalizing the sale (i.e., TAX 1) does not include a manual-entered tax, while the entire sale total printed on the receipt last line does include the manual-entered tax also.

This key is also used, if depressed without an amount entry within a sale, to display the total of only non-taxable items so far entered. Usually, this non-taxable items total is only displayed; however, it may be programmed to print also.



AT/TL

## AMOUNT TENDER / CASH TOTAL KEY

This key is used to finalize a cash sale, received-on-account payments, or paid-out items.

This key can be programmed to be used as one of the following three types of keys.

### 1. AMOUNT TENDER KEY

If so programmed, this key requires a tendered cash amount entry prior to depressing this key. The tax due is printed with the "TX" symbol, the sale total with the "TL" symbol (if ST has not been depressed priorly), the cash tendered amount with the "AT" symbol, and the change due with the "CG" symbol on separate lines.

When the tendered amount is less than the sale total, all the printing sequence above will be the same except that the balance due is displayed (not printed) instead of the change due. In this case, the sale is not yet finalized and another cash tendering must be done, or use other media keys (CHK TEND and/or Chg) if the balance due is processed as a sale in that media.

When the sale total is negative, as in some cases with returned merchandise entries, the AT/TL key must be depressed without a prior amount entry, just as in the case of "2. TOTAK KEY" below.

### 2. TOTAL KEY

If so programmed, this key is depressed without a prior amount entry for sale finalization. The tax due is printed with the "TX" symbol and the sale total is printed with the "CA" symbol on separate lines.

When the sale total is negative, the sale total is printed with the "-" as well as the "CA" symbol. In this case, the cashier must refund the amount in cash to the customer.

### 3. AMOUNT TENDER / TOTAL KEY

If so programmed, this key will function as TENDER KEY (as described in 1 above) when any prior amount is entered, and will function as TOTAL KEY (as described in 2 above) when depressed without an amount entry.

CHK  
TEND

#### CHECK TENDER KEY

This key is used to cash a check when the register is outside a sale, or to finalize a sale as check payment.

#### CHECK CASHING

When the register is outside a sale, enter the check amount and depress this key. A receipt is issued and the drawer is opened to enable exchange.

#### FINALIZING A SALE AS CHECK PAYMENT

On finalizing a sale, enter the amount of the check given by the customer and depress this key. If the amount received is larger than the sale total, the receipt is issued with the change due printed and displayed. Then the change is given to the customer in cash. If the amount received is smaller than the sale total, the shortage is displayed, and the customer may pay the additional amount in cash to finalize the sale by depressing the AT/TL.

A total of negative balance cannot be finalized by the CHK TEND key.

Chg

#### CHARGE TOTAL KEY

This key may be used to finalize a sale paid in non-cas media such as credit cards. Thus this key is used as alternative method of payment for media other than cash and check. To operate, depress the Chg key without a prior amount entry, instead of AT/TL, to obtain the total and finalize the sale.

A total of negative balance cannot be finalized by the Chg key.

## REGISTERING PROCEDURE FOR SALES

The following are patterns for actual registering operations. In the following examples, "|\_\_\_\_|" indicates an input through the numeric keys, "□" indicates a depression of the transaction key, and "---" indicates other registering and/or finalizing operations.

NO-SALE (Control Lock: REG, Clerk Key to ON)

□ (or □/NS)

DEPARTMENT ENTRY (Control Lock: REG, Clerk Key to ON)

|AMOUNT| □ DEPT → ---  
                  |  
                  Department Key (1 or 2)

SINGLE-ITEM DEPARTMENT ENTRY (Control Lock: REG, Clerk Key to ON)

|AMOUNT| □ DEPT 1 ... The sale is immediately finalized as cash.  
(This is applied only when the □ DEPT 1 key has been programmed to be used as "Single-item" key.)

PLU ENTRY (Control Lock: REG, Clerk Key to ON)

|PLU Code| □ PLU → ---  
  1~32

REPEAT ENTRY (Control Lock: REG, Clerk Key to ON)

|AMOUNT| □ DEPT □ DEPT □ DEPT ... → ---  
                  |          |          |  
                  └──────────┘

Repeat depressing the same Dept. Key as many times as the desired count.

|PLU Code| □ PLU □ PLU □ PLU ... → ---  
                  |          |          |  
                  └──────────┘

Repeat depressing the □ PLU key as many times as the desired count.

QUANTITY EXTENSION (MULTIPLICATION) (Control Lock: REG, Clerk Key to ON)

When Q'TY x PRICE order is programmed:

|QUANTITY| □ X |UNIT PRICE| □ DEPT → ---  
max. 3 dig.   max. 6 dig.  
integral  
portion only

(The product must not exceed 7 digits.)

|QUANTITY| □ X |PLU Code| □ PLU → ---

When PRICE x Q'TY order is programmed:

|UNIT PRICE|  |QUANTITY|  DEPT → ---

|PLU Code|  |QUANTITY|  PLU → ---

NOTE: Return Merchandise entry with multiplication is possible by depressing  RTN MDSE any time before the  DEPT or  PLU key during the operation sequences in the above four patterns.

RETURNED MERCHANDISE (Control Lock: REG, Clerk Key to ON)

RTN MDSE → |AMOUNT| →  DEPT → ---

RTN MDSE → |PLU Code| →  PLU → ---

NOTE: as for Return Merchandise with multiplication, see the "NOTE" above.

RETURNED MERCHANDISE WITH %- OR %+::

ex.) A customer bought a department item with a preset discount, which the cashier recorded as in the following operation:

|AMOUNT|  DEPT 1 → |10|  %- → ---

Manual rate of 10%

Now the customer later comes back to return the above item. The cashier must operate as in the following to make up the returned merchandise entry correctly:

RTN MDSE |AMOUNT|  DEPT 1 → |10|  %- → ---

The same amount recorded in the purchase above.

Thus the item amount and the percent discount is correctly returned.

DOLLAR DISCOUNT (Control Lock: REG, Clerk Key to ON)

--- → |DISCOUNT AMOUNT| →  DOLL DISC → ---

NON-ADD NUMBER PRINT (Control Lock: REG, Clerk Key to ON)

|NUMBER| →  # (or  #/NS) → ---

Max. 8 digits

PERCENT DISCOUNT (Control Lock: REG, Clerk Key to ON)

(1) To discount from the sub-total:

--- → ST → %- → --- ... to discount by the preset %- rate  
 --- → ST → RATE | → %- → --- ... to discount by a manual rate  
 0.01~99.99

(2) To discount from a Department or PLU item:

--- → DEPT ] → %- → --- ... to discount by the preset %- rate  
 --- → PLU ]  
 --- → DEPT ] → RATE | → %- → --- ... to discount by a manual rate  
 --- → PLU ] 0.01~99.99

NOTE: Use the . key if the rate contains the decimal point.  
 ex.) To enter 4.5%: operate 4 - . - 5.

PERCENT CHARGE (Control Lock: REG, Clerk Key to ON)

This operates the same as in the PERCENT DISCOUNT operations above, except that the %+ key is used instead of the %- key.

ITEM CORRECT (LAST-LINE VOID) (Control Lock: REG, Clerk Key to ON)

AMOUNT | DEPT | ITEM CORR → --- (The item marked with "\*" is invalidated from the sale.)  
 \*

AMOUNT | DEPT | same DEPT | same DEPT | ITEM CORR → ---  
 \*

(An item-correct after repeat entries will invalidate only the last one item of the repeated.)

PLU Code | PLU | ITEM CORR → ---  
 \*

Quantity Extension routine using DEPT or PLU → ITEM CORR → ---  
 \*

(An item-correct after a quantity extension will invalidate the product that is resulted from the multiplication.)

--- → ( MANUAL RATE | ) %- (or %+ ) | ITEM CORR → ---  
 \*

AMOUNT | R/A | ITEM CORR → ---  
 \*

AMOUNT | PO | ITEM CORR → ---  
 \*

AMOUNT | DOLL DISC | ITEM CORR → ---  
 \*

AMOUNT | TAX | ITEM CORR → ---  
 \*

TAX MODIFICATION (REVERSING THE TAX STATUS) (Control Lock: REG, Clerk Key to ON)

Depress TX/M, TX1/M, or TX2/M at any one of the positions marked with "\*" in each operation pattern.

- TX/M ... to reverse the tax status of the item in a single-tax area (i.e., from taxable to non-taxable, or vice versa)
- TX1/M ... to reverse the Tax 1 status of the item in a dual-tax area (i.e., from Tax 1 taxable to non-taxable, or vice versa)
- TX2/M ... to reverse the Tax 2 status of the item in a dual-tax area (i.e., from Tax 2 taxable to non-taxable, or vice versa)
- TX1/M TX2/M ... to reverse both Tax 1 status and Tax 2 status of the item in a dual-tax area)

--- \* |AMOUNT| \* DEPT → ---  
 --- \* |PLU Code| \* PLU → ---  
 --- \* |QUANTITY| \* X \* |UNIT PRICE| \* DEPT → ---  
 --- \* |QUANTITY| \* X \* |PLU Code| \* PLU → ---  
 --- \* |AMOUNT| \* DOLL DISC → ---  
 --- \* (|RATE|) \* %- (or %+) → ---

RECEIVED ON ACCOUNT (Control Lock: REG, Clerk Key to ON)

|PAYMENT AMOUNT TO BE RECEIVED| R/A → (|AMOUNT TENDERED|) → AT/TL  
 ↑ |CHK TEND|  
 ↑ May be repeated if multiple items. ↑ May be repeated if short-tendered.  
 (Must be operated outside a sale.)

PAID OUT (Control Lock: REG, Clerk Key to ON)

|AMOUNT PAID OUT FROM THE CASH DRAWER| PO → AT/TL  
 ↑ May be repeated if multiple items.  
 (Must be operated outside a sale.)

SUB-TOTAL (Control Lock: REG, Clerk Key to ON)

--- → ST → --- ... The sale total so far is displayed and printed, but the sale is not yet finalized.

TAXABLE TOTAL READ (Control Lock: REG, Clerk Key to ON)

--- → TXBL TL → --- ... The amount of sale total with taxes due so far is displayed only (but not printed).

NON-TAXABLE ITEMS TOTAL READ (Control Lock: REG, Clerk Key to ON)

--- → TAX → --- ... The non-taxable items total out of the entire sale is displayed (also printed if so programmed).

MANUAL TAX ADDITION (Control Lock: REG, Clerk Key to ON)

--- → TAX AMOUNT TO BE ADDED | TAX → ---

CHECK CASHING (Control Lock: REG, Clerk Key to ON)

AMOUNT OF CHECK TO BE CASHED | CHK TEND

(Must be outside a sale)

CASH TOTAL (Control Lock: REG, Clerk Keys to ON)

--- → ( TXBL TL ) → AT/TL ... The drawer opens, the sale total is displayed and printed, and a receipt is issued.

CASH TENDERING (Control Lock: REG, Clerk key to ON)

--- → ( TXBL TL ) → TENDERED CASH AMOUNT | AT/TL ... The change due is displayed, the drawer opens, and a receipt is issued.

CHECK TENDERED (Control Lock: REG, Clerk Key to ON)

--- → ( TXBL TL ) → TENDERED CHECK AMOUNT | CHK TEND ... The same as CASH TENDERING above.

CHARGE TOTAL (Control Lock: REG, Clerk Key to ON)

--- → ( TXBL TL ) → Chg ... The same as CASH TOTAL above.

RECEIPT POST-ISSUE (Control Lock: REG, Clerk Key to ON,  
RECEIPT ON/OFF SWITCH: OFF)

A sale is finalized → RCPT ISSUE ... A receipt with only the sale total amount printed is issued.

**MULTI-TENDERING (Control Lock: REG, Clerk Key to ON)**

... Short-tendering repeated multiple times by cash or check (by one media).

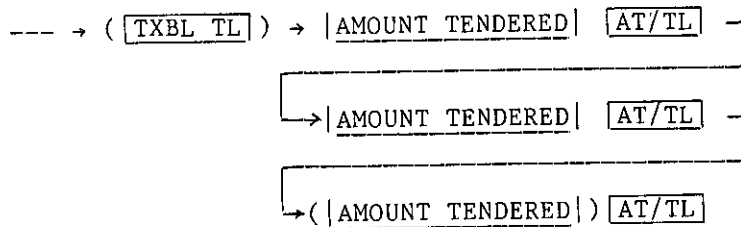

The [ AT/TL ] may be replaced by the [ CHK TEND ] Key.

**SPLIT-TENDEIRNG (Control Lock: REG, Clerk Key to ON)**

... Short-tendering repeated multiple times by different medias.

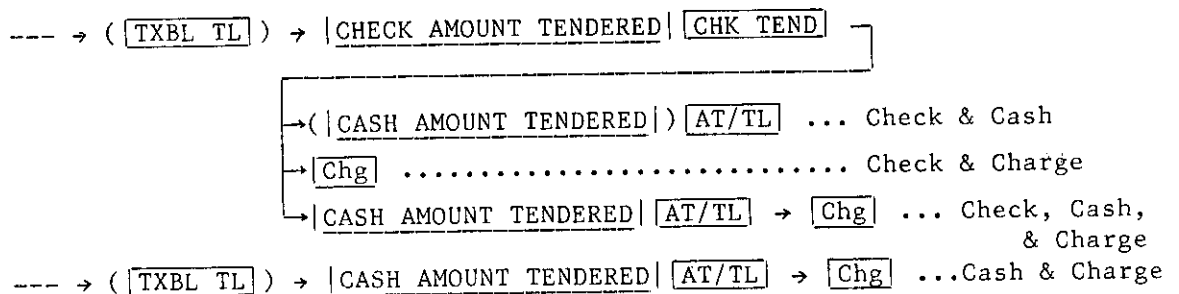

- NOTES:**
1. In both MULTI-TENDERING and SPLIT-TENDERING operations, the sale is finalized, a receipt is issued, and the drawer opens on reaching the sale total amount.
  2. If [ Chg ] is depressed or [ AT/TL ] is depressed without an amount tendered entry (if the [ AT/TL ] functions as the "Total" key), the sale is then finalized on that stage processing all the balance due into that media.

**VALIDATION PRINT (Control Lock: REG, Clerk key to ON)**

After entering the required item through a transaction key or a media key. → Insert a validation slip into the validation slot. → [ VALIDATE ]  
 Make sure that the "SLP" tri-mark appears on the display bottom.

- NOTES:**
1. No other operations can follow until the validation slip once set is withdrawn.
  2. The following are the selections that can be programmed related to validation:
    - (1) PRINT FORMAT WITH or WITHOUT CONSECUTIVE NO.
    - (2) MULTI-VALIDATION or SINGLE-VALIDATION  
 (The number of validations available for the same item)



REGISTERING RECEIPT SAMPLES

NO-SALE

Thank you  
Call again

06-04-84  
2333333

\* 2

12-0025  
14-05

Store Name/Message Stamp

Date

Register No.

No-sale Symbol

Clerk ID / Consecutive No.

Current Time

CHECK CASHING

Thank you  
Call again

06-04-84  
2333333

\*1.00 2

12-0041  
14-21

Check Amount Cashed

NON-ADD NUMBER,  
RECEIVED ON ACCOUNT

Thank you  
Call again

06-04-84  
2333333

#15

\*10.00 RA

\*2.50 RA

\*12.50 RA ST

\*10.00 CK

\*2.50 CA

12-0031  
14-10

Non-add Number

R/A item of \$10.00

R/A item of \$2.50

Sub-toal

Received in Check

Received in Cash

PAID OUT,  
ITEM CORRECT

Thank you  
Call again

06-04-84  
2333333

\*3.00 2

\*2.00 2

-----\*0.15-25

\*1.50 2

\*6.50 2F

12-0032  
14-11

Paid Out item \$3.00

Paid Out item \$2.00

Paid Out item \$0.15, but

Paid Out item \$1.50 item-corrected

Paid Out Total

DEPARTMENT ENTRY

Thank you  
Call again

06-04-84  
2333333

1 \*1.23 E  
2 \*4.56  
1 \*0.50 E  
1 \*0.50 E  
1 \*0.50 E  
\*0.27 X  
\*7.56 S  
5 \*  
12-0026  
14-05

Taxable Item Symbol

\$1.23 into Dept.1  
\$4.56 into Dept.2 (non-tbl)  
\$0.50 into Dept.1  
repeated three times.  
Tax due  
Total Paid in Cash  
Total Item Count of  
the sale (option print)

DEPARTMENT QUANTITY EXTENSION,  
ITEM CORRECT ON DEPARTMENT ITEM

Thank you  
Call again

06-04-84  
2333333

12 X  
0.50 @  
1 \*6.00 E  
2 --- \*4.00 - S  
5 X  
1.20 @  
2 --- \*6.00 - E S  
\*0.60 X  
\*6.60 S  
12 \*  
12-0027  
14-06

12 x \$0.50@ = \$6.00  
into Dept.1  
\$4.00 into Dept.2, but  
Item-corrected  
5 x \$1.20@ = \$6.00 into  
Dept.2, but Item-corrected

AMOUNT TENDERING,  
CHANGE COMPUTATION

Thank you  
Call again

06-04-84  
2333333

1 \*1.30 E  
2 \*2.50  
\*0.13 X  
\*3.93 T  
\*50.00 AT  
\*46.07 S  
2 \*  
12-0028  
14-08

Tax due  
Sale Total including Tax  
Cash \$50.00 Tendered  
Change due

NON-ADD NUMBER PRINT,  
CHARGE SALE, SUB-TOTAL PRINT

Thank you  
Call again

06-04-84  
2333333

#123456  
1 \*0.45 E  
2 \*1.23  
2 \*1.23  
\*2.91 S  
\*0.05 X  
\*2.96 S  
3 \*  
12-0029  
14-09

Non-add # (ex. Customer No.)  
Sub-total Amount  
Finalized as Charge

RETURNED MERCHANDISE

Thank you  
Call again

06-04-84  
2333333

1 \*0.50 ₪ — \$0.50 returned into Dept.1  
 1 \*1.80 ₪ — \$1.80 purchased (Dept.10)  
 \*0.13 ₪  
 \*1.43 ₪ — Sale Balance

0 \*

14-0030  
14-10

PLU ENTRY

Thank you  
Call again

06-04-84  
2333333

05 2 \*1.00 ₪ — PLU No.5 \$1.00 repeated twice  
 05 2 \*1.00 ₪  
 4 X — 4 x (PLU No.30 \$10.00@) = \$40.00  
 10.00 @  
 30 2 40.00  
 \*0.20 ₪  
 \*42.20 ₪  
 6 \*

14-0035  
14-13

PERCENT CHARGE,  
PERCENT DISCOUNT

Thank you  
Call again

06-04-84  
2333333

1 \*1.00 ₪ — \$1.00 into Dept.1  
 10 % + — 10% added to the above Dept.1 item  
 \*0.10  
 2 \*2.00  
 \*3.10 ₪ — Sub-total  
 5 % - — 5% discount from the above sub-total amount.  
 -0.16  
 \*0.10 ₪  
 \*3.04 ₪

2 \*

14-0036  
14-14

DOLLAR DISCOUNT,  
CHECK SALE

Thank you  
Call again

06-04-84  
2333333

1 \*3.50 ₪  
 1 \*3.50 ₪ — Dollar Discount of \$0.40  
 -0.40 ₪  
 \*0.66 ₪  
 \*7.26 ₪  
 \*7.50 ₪ — Check Tendered  
 \*0.24 ₪ — Change due

2 \*

14-0033  
14-12

MULTI-TENDERING,  
SPLIT-TENDERING

Thank you  
Call again

06-04-84  
2333333

1    \*4.50   ₣  
2    \*2.50  
      \*0.45   ₣  
      \*7.45   ₣  
      \*2.00   ₣  
      \*3.00   ₣  
      \*2.45   ₣

2    \*

14-0034  
14-12

—Sale Total \$7.45  
—Cash-paid Portion \$2.00  
—Another Cash-paid Portion \$3.00  
—The rest Paid as Charge \$2.45

RECEIPT POST-ISSUE

When the register is operated with the RECEIPT ON/OFF SWITCH positioned to "OFF", no receipt will be issued but the sale content is recorded on the journal roll only. If the customer claims for the sale receipt in that case, depress the RCPT ISSUE key before going into another sale. Ther receipt with only the sale total printed will be issued, no matter in what media the sale was finalized.

JOURNAL PRINT

1    \*1.00   ₣  
2    \*2.00  
      \*0.10   ₣  
      \*3.10   ₣  
      \*5.00   ₣  
      \*1.90   ₣

2    \*

14-0046  
14-34

RECEIPT POST-ISSUED

Thank you  
Call again

06-04-84  
2333333

      \*3.10   ₣

14-0046  
14-35

VALIDATION PRINT SAMPLES

(RECEIPT PRINT)

(VALIDATION PRINT)

Thank you  
Call again

06-04-84  
9333333

1 \*1.00 FM  
2 \*2.00  
\*3.00 ST  
\*0.10 TX  
\*3.10 TL  
\*2.00 CK  
\*1.00 AT  
\*0.10 CA

2 \*  
14-0037  
14-15

06-04 037	1	*1.00	F
06-04 037		*3.00	S
06-04 037		*2.00	S
06-04 037		*1.00	CA
06-04 037		*0.10	S

Date (MONTH-DAY)      Amount      Item

The last 3 digits of the Consecutive No.

If the option "Consecutive No. Non-print on Validation" is selected, the full date form "MONTH-DAY-YEAR" (ex. 06-04-84) will be printed here.

RECEIVED ON ACCOUNT

Thank you  
Call again

06-04-84  
9333333

#55  
\*1.50 RAIRA  
\*1.00 RAIRA  
\*2.50 ST  
\*2.50 CA

14-0038  
14-17

06-04 038	#55		
06-04 038		*1.50	F
06-04 038		*2.50	S
06-04 038		*2.50	S

# READ(X) AND RESET(Z) REPORTS

The following are the key operations and print samples of X and Z reports. The print contents of the both reports are the same. But please note that all the resettable counters and totals will be reset when a Z report has been taken.

TABLE OF REPORTS

REPORT NAME	CONTROL LOCK	KEY OPERATION	PRINT CONTENT	SAMPLE PAGE
PLU READ REPORT	X	[PLU]	All PLUs' Sales Data. PLUs with no sales record will be skipped.	26
PLU RESET REPORT	Z			
AUTO READ REPORT	X	[AT/TL]	All Sales Data except PLUs.	27 - 28
AUTO RESET REPORT	Z			

- NOTES: 1. One of the Clerk Keys must also be set to ON for taking any of the reports.  
 2. For programmed data reading, refer to "PROGRAM VERIFICATION" which is described near the end of this manual.

## PLU READ REPORT

```

Thank you
Call again

06-04-84
2333333

      X
05 ¢
      2
      *2.00
30 ¢
      4
      *40.00
1¢-0042
14-22
    
```

Control Lock: X or Z,  
Clerk Key to ON.

Depress [PLU].

- Date
- Register No.
- X Report Symbol ← → Z Report Symbol
- PLU No.5
- Sales Item Count
- Sales Total
- Clerk ID / Consecutive No.
- Current Time

## PLU RESET REPORT

```

Thank you
Call again

06-04-84
2333333

      Z
05 ¢
      2
      *2.00
30 ¢
      4
      *40.00
0.001Z
1¢-0044
14-22
    
```

Reset Count →  
(on Z Report only)

Thank you  
Call again

06-04-84  
333333

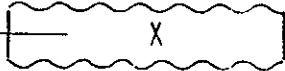
	Z		Z Report Symbol	←	X Report Symbol	→	
	*96.59	5	Grand Total (non-resettable)				
	43	8	Gross Sales Item Count				
	*96.59	8	" " Total				
1	25		Dept.1 Sales Item Count				
	*27.28		" " Total				
2	11		Dept.2 Sales Item Count				
	*56.02		" " Total				
	1	%+	Percent Charge Count				
	*0.10	%+	" " Total			(without Tax)	
1						(Net Sales Item Count and Total on CA-balance Version)	
	*2.69	F	Tax 1 Total				
	36					(Tax 2 Total in a dual-tax area)	
	*86.09	8	Net Sale (with Tax) Item Count			on US-balance Version	
			" " " " Total				
	1	%-	Percent Discount(on Sub-total) Count				
	*0.16	%-	" " " " Total				
	1	-	Dollar Discount Count				
	*0.40	-	" " Total				
	10	8 TL	Total Customer Count				
	*85.53	TL	Total of All Media Sales				
	7	8 8	Cash Sales Customer Count				
	*70.86	8 TL	" " Total				
	1	8 8	Check Sales Customer Count				
	*9.26	8 TL	" " Total				
	2	8 8	Charge Sales Customer Count				
	*5.41	8 TL	" " Total				
	4	RA	Received on Account Count				
	*15.00	RA TL	" " " Total				
	5	PO	Paid Out Count				
	*13.50	PO TL	" " Total				
	*56.12	CA ID	Cash-in-drawer Total				
	5	CK	Check-in-drawer Count				
	*25.50	CK ID	" " " Total				

-- To be continued --

-- Continued --

2	VD	— Item Correct Count	} on Departments and PLUs (VD)
*10.00	VD	— " " Total	
2	VD	— Item Correct Count	} on other items (VD2)
*0.15	VD	— " " Total	
0	% -	— Percent Discount(on Department and PLU items) Count	
*0.00	% -	— " " " Total	
1	RT	— Returned Merchandise Item Count	
*0.50	RT	— " " Total	
1 d **		← (No-sale Count; option print)	
		— CLERK 1 SALES DATA:	
10	B	— Total Customer Count	
43		— Item Count	
*96.59	S	— Gross Sales Total	
**		← (Other Clerks' Data will also be printed here, if any sales are recorded.)	
		— HOURLY DATA:	
08-00		} No sales data was recorded here.	
09-00			
10-00			
13-00			
10	B	— Customer Count	
*86.09	F	— Hourly Range Sales Total (Net Sales With Tax for US-balance Version, Net Sales Without Tax for CA-balance Version)	
16-00		} No sales data was recorded here.	
18-00			
0.001Z		← Reset Count (on Z reports only)	
1 d - 0045		— Clerk ID / Consecutive No.	
14-22		— Current Time	



# PROGRAMMING OF THE REGISTER

In this chapter, various programming operations are described. Please follow the directions of each operation when any data must be changed or newly set.

## TABLE OF PROGRAMMING CONTENTS

(PROGRAM ITEM)	(CONDITION)	(PROG.NO.)(PAGE)
DEPARTMENT TAX STATUS SETTING .....	After Auto Z .....	1 .... 30
DEPARTMENT LC SETTING .....	After Auto Z .....	2 .... 32
PLU CODE SETTING AND DELETION .....	After PLU Z for Change, Anytime for Additional ..3	.... 33
HOURLY RANGE SETTING .....	After an Auto Z .....	4 .... 34
TIME SETTING .....	Anytime .....	5 .... 35
DATE SETTING .....	Anytime .....	6 .... 35
REGISTER NO. SETTING .....	After Auto Z .....	36
%+, %- PRESET RATE SETTING .....	Anytime .....	36
PLU PRESET PRICE CHANGE .....	Anytime .....	37
SETTING TAX TABLE .....	After Auto Z .....	38
NON-TAXABLE AMOUNT LIMIT SETTING .....	After Auto Z .....	9 .... 40
-----		
PROGRAM VERIFICATION		
DEPARTMENT LC & % RATE READ .....		41
PLU TABLE READ .....		41
TAX CALCULATION TEST .....		42

**NOTE:** If data any other than the listed above must be changed, please contact your local TEC representative.

## DEPARTMENT TAX STATUS SETTING

This operation determines the taxable/non-taxable status of each department.

CONDITION: After an Auto Reset

OPERATION: Control Lock: SET, one of the Clerk Keys must be set to ON.

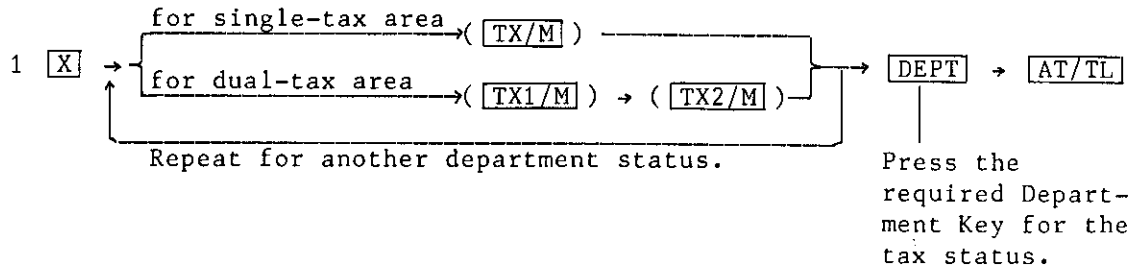

- NOTES:**
- Among TX1/M (TX/M) and TX2/M keys, depress the key(s) for the required status change(s) for each department.
  - Depressing any of the three keys above, the related status reverses. For example, depressing the TX/M reverses a non-taxable DEPT to a taxable or taxable to non-taxable. Each department status is read by the number indicated on the display when each department key is depressed in the above operation. The numbers and their respective statuses are:

0: Non-taxable	} for single-tax area	} for dual-tax area
1: Tax 1 Taxable		
2: Tax 2 Taxable		
3: Tax 1 and Tax 2 both Taxable		

Watching the number, adjust the status by depressing those keys. See the examples below. The TX/M (for single-tax area) operates the same as the TX2/M.

STATUS NUMBER BEFORE CHANGE	KEY-IN FOR CHANGE PRIOR TO <u>DEPT</u> KEY	NEW NUMBER AND STATUS OBTAINED
0 (Non-taxable)	→ <u>TX1/M</u>	→ 1 (Tax1 only)
0	→ <u>TX1/M</u> <u>TX2/M</u>	→ 3 (Tax1 & Tax2)
0	→ <u>TX2/M</u>	→ 2 (Tax2 only)
1 (Tax1)	→ <u>TX1/M</u>	→ 0 (Non-taxable)
1	→ <u>TX2/M</u>	→ 3 (Tax1 & Tax2)
1	→ <u>TX1/M</u> <u>TX2/M</u>	→ 2 (Tax2 only)
2 (Tax2)	→ <u>TX2/M</u>	→ 0 (Non-taxable)
2	→ <u>TX1/M</u>	→ 3 (Tax1 & Tax2)
3 (Tax1 & Tax2)	→ <u>TX1/M</u>	→ 2 (Tax2 only)
	etc.	

OPERATION SAMPLE:

Presumed that all the departments have been set as non-taxable.

To set Dept. 1 as taxable department,  
Dept. 2 as non-taxable department.  
(in a single-tax area)

Control Lock: SET,  
Clerk 1 Key to ON.

Enter 1, depress  X .  
Depress  TX/M and  DEPT 1 .  
Depress  DEPT 2 .

Depress  AT/TL to end.

Thank you  
Call again

06-04-00  
20

#-01

1 1

2 0

13-0006

13-53

**DEPARTMENT LC SETTING**

The listing capacity (LC) for each department and the common LC for all departments can be set in this operation. If the LC for an individual department is once set, that LC prevails over the common LC. The common LC becomes effective for entries through a department which has not been set with its individual LC.

CONDITION: After an Auto Reset

OPERATION: Control Lock: SET, one of the Clerk Keys must be set to ON.

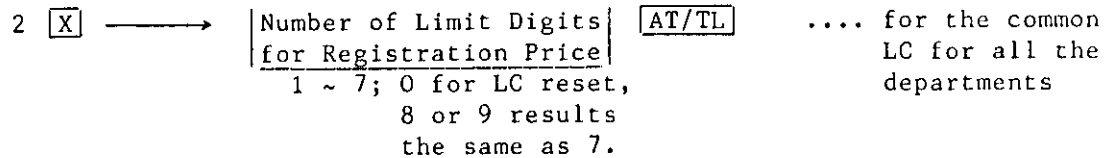
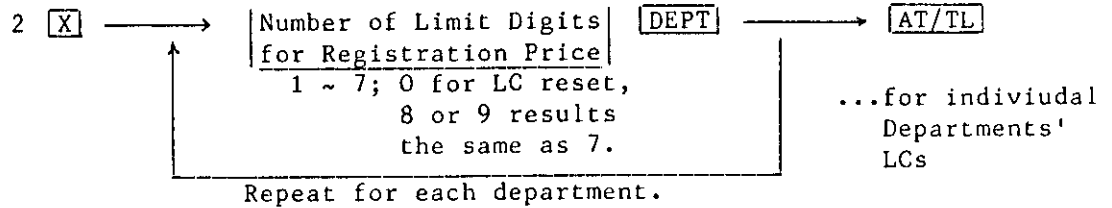

The above two operations may be combined as follows:

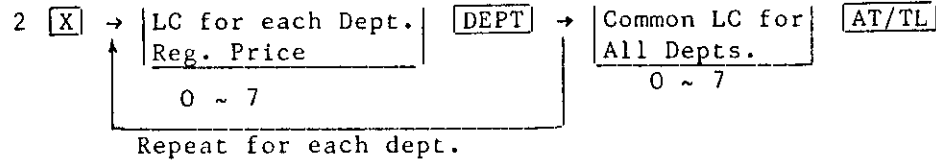

SAMPLE OPERATION:

To set the following LCs:

- Dept.1: 3 digits
- Dept.2: 4 digits
- Common LC: 6 digits

Control Lock: SET, Clerk 1 Key to ON.

- Enter 2, depress [X].
- Enter 3, depress [DEPT 1].
- Enter 4, depress [DEPT 2].
- Enter 6, depress [AT/TL].

Thank you  
Call again

06-04-00  
20

#-0.2

1	3
2	4
	6

12-000.7  
13-54

**PLU CODE SETTING**

A maximum of 32 PLUs can be set. Each PLU is programmed with its PLU Code No. (1 to 32), preset price (max. 6 digits), and its linking Department No.

CONDITION: After a PLU Reset for changing data with the old PLU Codes, or any time outside a sale for additional PLU setting.

OPERATION: Control Lock: SET, one of the Clerk Keys must be set to ON.

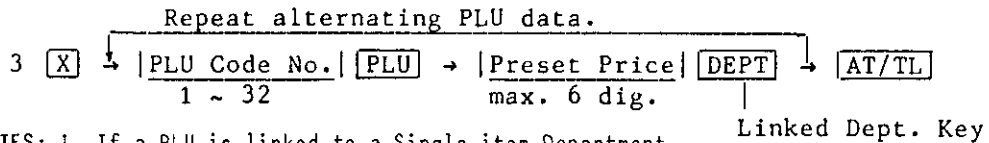

- NOTES: 1. If a PLU is linked to a Single-item Department, the PLU will also function as Single-item PLU.  
 2. The tax status of each PLU is ruled by that of the linked department.

SAMPLE OPERATION:

To set the following PLUs:

PLU Code No.	Preset Price	Link Dept.
5	1.00	DP 1
10	2.00	DP 1
11	123.00	DP 2
30	10.00	DP 2

Control Lock: SET, Clerk 1 Key to ON.  
 Enter 3, depress [X].  
 Enter 5, depress [PLU],  
 enter 100, depress [DP 1].  
 Enter 10, depress [PLU],  
 enter 200, depress [DP 1].  
 Enter 11, depress [PLU],  
 enter 12300, depress [DP 2].  
 Enter 30, depress [PLU],  
 enter 1000, depress [DP 2].  
 Depress [AT/TL] to end.

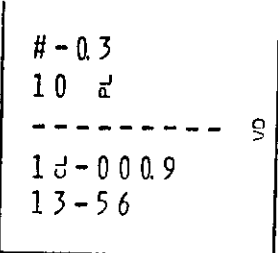
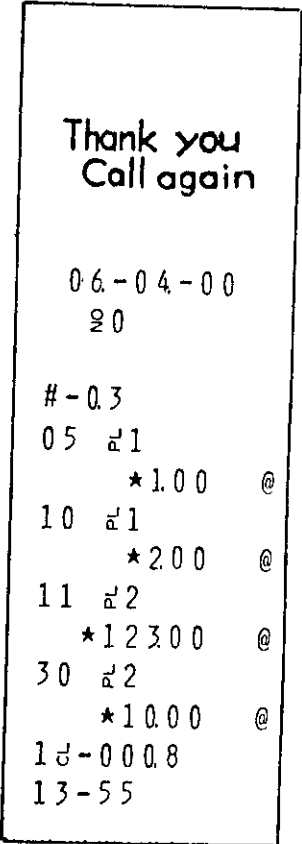

**PLU CODE DELETION**

CONDITION: After a PLU Reset

OPERATION: Control Lock: SET, one of the Clerk Keys must be set to ON.

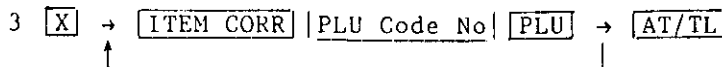

Print Sample when PLU No.10 is deleted.

## HOURLY RANGE SETTING

A maximum of 16 hourly ranges may be set. By setting hourly ranges, the sales data are processed into each hourly range memory which will be read on Auto X and Z reports.

CONDITION: After an Auto Reset

OPERATION: Control Lock: SET, one of the Clerk Keys must be set to ON.

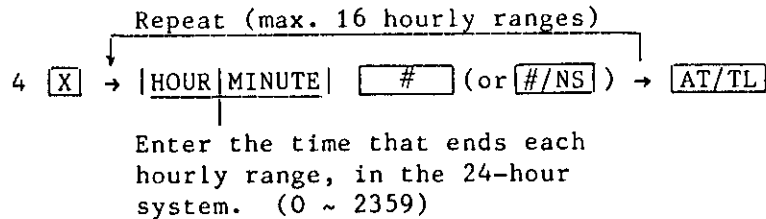

- NOTES: 1. To change the hourly range table once set, partially or entirely, do the entire setting operation over again.
2. To reset the hourly range table and not to provide any hourly ranges, operate in the "SET" mode:  
 4 [X] → 0 [ # ] (or [#/NS]) → [AT/TL]
3. Do not set an hourly range across 24:00, such as "from 23:00 to 1:00". If ever set, no data will be processed into that hourly range.

### SAMPLE OPERATION:

To set the following hourly range table:

<u>Table</u>	<u>Key Operation</u>
	Control Lock: SET. Clerk 1 Key to ON.
	Enter 4, depress [X].
up to 8:00	Enter 800, depress [ # ] .
8:00 ~ 9:00	Enter 900, depress [ # ] .
9:00 ~ 10:00	Enter 1000, depress [ # ] .
10:00 ~ 13:00	Enter 1300, depress [ # ] .
13:00 ~ 16:00	Enter 1600, depress [ # ] .
16:00 ~ 18:00	Enter 1800, depress [ # ] .
	Depress [AT/TL] to end.

Thank you  
Call again

06-04-00  
20

#-0.4  
08-00  
09-00  
10-00  
13-00  
16-00  
18-00  
13-001.0  
13-56

**TIME SETTING**

A time-of-day clock and standard calendar circuit is installed. Therefore, once the time and the date are properly set, seldom is adjustment necessary. Neither is a leap year adjustment necessary.

CONDITION: Any time outside a sale

OPERATION: Control Lock: SET, one of the Clerk Keys must be set to ON.

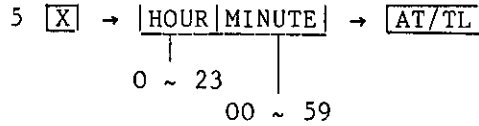

SAMPLE OPERATION:

To set the time to "1:57 p.m." (i.e. "13:57")

Control Lock: SET,  
Clerk 1 Key to ON.

Enter 5, depress [X].  
Enter 1357, depress [AT/TL].

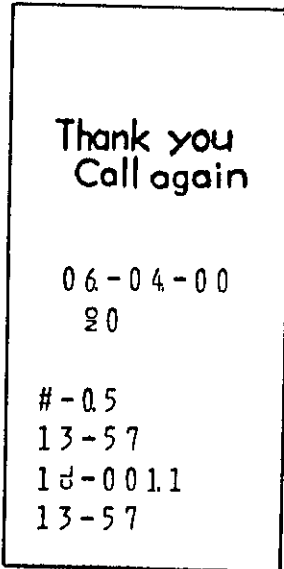

**DATE SETTING**

CONDITION: Any time outside a sale

OPERATION: Control Lock: SET, one of the Clerk Keys must be set to ON.

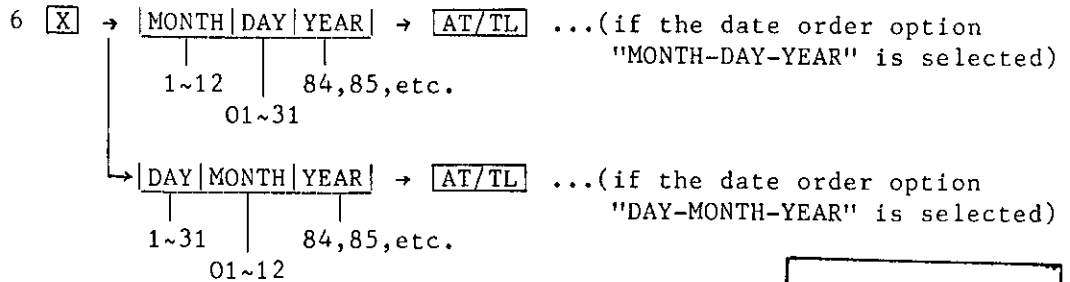

SAMPLE OPERATION:

To set the date to "June 4th, 1984":  
(with date order option MONTH-DAY-YEAR)

Control Lock: SET,  
Clerk 1 Key to ON.

Enter 6, depress [X].  
Enter 6 0 4 8 4, depress [AT/TL].

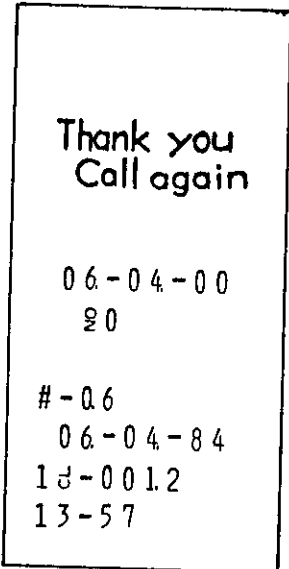

## REGISTER NO. SETTING

A maximum of 6-digit number may be set as Register No.

CONDITION: After an Auto Reset

OPERATION: Control Lock: SET, one of the Clerk Keys must be set to ON.

|Register No.| →  # (or  #/NS )  
0 ~ 999999

### SAMPLE OPERATION:

To set Register No. of "333333":

Control Lock: SET,  
Clerk 1 Key to ON.

Enter 333333, depress  #/CID .

## %+, %- PRESET RATE SETTING

Each of the  %+ and  %- keys can be set with a preset rate independent from the other. Once a rate is preset, a simple depression of the % key will function with the rate in the REG mode. If a manual rate is entered before the % key, it will function with the manual rate instead. If 0% is preset, the % key will always require a manual rate entry.

CONDITION: Any time outside a sale

OPERATION: Control Lock: SET, one of the Clerk Keys must be set to ON.

|%+ Preset Rate| →  %+

|%- Preset Rate| →  %-

0 ~ 99.99

(Use the  . key  
if a decimal point  
is contained.)

### SAMPLE OPERATIONS:

To set 10% for %+ Preset Rate,  
10.5% for %- Preset Rate:

Control Lock: SET, Clerk 1 Key to ON.

Enter 10, depress  %+ .  
Enter 10, depress  ., enter 5,  
depress  %- .

Thank you  
Call again

06-04-84

20

2333333

12-001.5

13-59

Thank you  
Call again

06-04-84

2333333

#10. %+

12-001.6

13-59

06-04-84

2333333

#10.5 %-

12-001.7

13-59



## PLU PRESET PRICE CHANGE

When only the preset prices of PLUs but not PLU Code No. or linking Department, you do not have to go through the "PLU CODE SETTING" operation described on page 33, but can easily change the prices in the following operation:

CONDITION: Any time outside a sale

NOTE: If the preset price of a PLU is changed during the day before an Auto Reset Report operation, the sales data printed on the Auto Read or Reset Reports may not result in the correct total amount, because the report data of each PLU will be calculated by (Sales Item Count) x (Newest Preset Price). For this reason, it is suggested that PLU Price Changing be executed after an Auto Reset as much as possible.

OPERATION: Control Lock: SET, one of the Clerk Keys must be set to ON.

Repeat for another PLU price change, if any.

→ PLU Code No. | PLU → New Price | # (or #/NS) → AT/TL  
max. 6 dig.

### SAMPLE OPERATION:

To change the preset price of PLU No.11 from \$123.00 (old price)  
to \$12.34 (new price):

Control Lock: SET.  
Clerk 1 Key to ON.

Enter 11, depress PLU.  
Enter 1234, depress #.

Depress AT/TL to end.

Thank you  
Call again

06-04-84  
2333333

11 2  
\*1234 @  
14-0021  
14-02

## SETTING TAX TABLE

The MA-132 model can calculate tax using one of three methods of tax calculation, which can be set in the programmable memory. The three methods are:

1. FULL-BREAK METHOD (COMBINATION OF NON-CYCLIC BREAKS AND CYCLIC BREAKS)  
(Maximum 64 breaks programmable for Tax 1 and Tax 2 tables altogether)
2. COMBINATION OF NON-CYCLIC BREAKS AND % RATE  
(Maximum 64 breaks programmable for Tax 1 and Tax 2 tables altogether)
3. % RATE ONLY

CONDITION: After an Auto Reset

OPERATION: Control Lock: SET, one of the Clerk Keys must be set to ON.

Select one of the following three methods to meet your tax status. Use TX1/M for Tax 1 Table and TX2/M for Tax 2 Table respectively in a dual-tax area, in place of TX/M in the following descriptions for the single tax table setting operations.

### 1. FULL-BREAK METHOD

#### Non-cyclic Breaks

- 1) Enter the first break point of price that is the non-taxable limit, and depress TX/M.
- 2) Enter the next break point of price that is the limit to collect the tax amount 1¢, and depress TX/M.
- 3) Repeat Step 2) above, with alternating each limit price for collecting tax amount of 2¢, 3¢, 4¢ ... until the non-cyclic breaks are all entered.
- 4) Depress ST to end the non-cyclic break entries.

#### Cyclic Breaks

- 1) Do the same operation as in Step 1) above, entering each limit price for each tax amount that increases by 1¢, followed by the TX/M key. Enter the last price so that the difference between the last non-cyclic break price already entered and the last cyclic one will be a multiple of one dollar (\$9.00 maximum). Otherwise, the tax calculation will not function.
- 2) Depress AT/TL to end the cyclic break entries as well as the entire tax program.

### 2. COMINATION OF NON-CYCLIC BREAKS AND % RATE

#### Non-cyclic Breaks

- 1) Do the same operation stated above in 1 from Steps 1) through 4) of Non-cyclic Breaks.

#### % Rate

- 1) Enter the tax percentage rate applied to amounts above the non-cyclic breaks. (The rate may be entered in maximum 4 digits; 2 digits above and 2 digits below the decimal point. For example, to set 4%, enter 400).

2) Depress **AT/TL** to end the percentage rate entry as well as the entire tax program.

3. % RATE ONLY

- 1) Enter "0", depress **TX/M**, and depress **ST**.
- 2) Enter the percentage rate in the same manner as in 2 - Step 1) above. Then depress **AT/TL** to end the entire tax program.

- NOTES: 1. A maximum of 4 digit value is entered for each break.  
 2. If any incorrect value is found to have been entered, first complete the entire tax table program (up to the **AT/TL** key operation), and do the correct tax table program operation over again from the frist.  
 3. In a dual-tax area, program Tax 1 Table first, and then Tax 2 Table. When Tax 1 Table is programmed, Tax 2 Table (if any pre-programmed) will automatically be reset.

SAMPLE OPERATION: To program the following tax table:  
 (in a single-tax area)

1. FULL-BREAK METHOD

<u>Tax Table</u>			<u>Key Operation</u>	
(from)	(to)	(tax)	(Enter)	(Depress)
Non-cyclic Breaks				
0¢	15¢	0¢	15	<b>TX/M</b>
16	25	1	25	<b>TX/M</b>
				<b>ST</b>
Cyclic Breaks				
26	45	2	45	<b>TX/M</b>
46	65	3	65	<b>TX/M</b>
66	85	4	85	<b>TX/M</b>
86	105	5	105	<b>TX/M</b>
106	125	6	125	<b>TX/M</b>
				<b>AT/TL</b>

2. COMINATION OF NON-CYCLIC BREAKS AND % RATE

Non-cyclic Breaks				
0¢	19¢	0¢	19	<b>TX/M</b>
20	39	1	39	<b>TX/M</b>
40	59	2	59	<b>TX/M</b>
60	79	3	79	<b>TX/M</b>
80	99	4	99	<b>TX/M</b>
				<b>ST</b>
			500	<b>AT/TL</b>

5% applied to any amount above Non-cyclic Breaks

Thank you  
Call again

06-04-84  
2333333

#1  
 00 \*0.15 E  
 01 \*0.25 E  
       \*0.25 ST  
 02 \*0.45 E  
 03 \*0.65 E  
 04 \*0.85 E  
 05 \*1.05 E  
 06 \*1.25 E  
       \*1.25 F  
 12-001.8  
 14-00

#1  
 00 \*0.19 E  
 01 \*0.39 E  
 02 \*0.59 E  
 03 \*0.79 E  
 04 \*0.99 E  
       \*0.99 S  
       5 %  
 12-001.9  
 14-01

3. % RATE ONLY

10% applied to any amount

0 TX/M  
ST  
1000 AT/TL

#1		
00	*0.00	ST
	*0.00	ST
10		%
10-00	2.0	
14-01		

**NON-TAXABLE AMOUNT LIMIT SETTING**

CONDITION: After an Auto Reset; this program is applied only to restaurants in Province of Quebec, Canada.

If this program has been set, the tax is calculated and added to the sale total which exceeds the limit amount even when the sale is entirely composed of non-taxable items. The tax levied when exceeding this limit amount will be calculated by the Tax 1 Table which has just been described.

OPERATION: Control Lock: SET, one of the Clerk Keys must be set to ON.

9 [X] → |Non-taxable Limit Amount| → [AT/TL]  
max. 4 digits (\$99.99)

- NOTES:
1. To reset the limit amount once set, enter "0" as the "Non-taxable Limit Amount" in the above operation.
  2. This tax calculation program will be disregarded when the sale total is negative.

ex.) When the limit amount is set to "\$3.25":

Case 1) Normal Department Entry (Control Lock: REG)

[326] → [non-taxable DEPT] → [AT/TL]

... The entered amount \$3.26 is greater than the limit \$3.25. It will therefore be taxed.

Case 2) Returned Merchandise Entry (Control Lock: REG)

[RTN MDSE] → [326] → [non-taxable DEPT] → [AT/TL]

... The non-taxable total is negative. The tax already levied will therefore not be returned.

SAMPLE OPERATION:

To set the Non-taxable Amount to \$20.00:

Control Lock: SET,  
Clerk 1 Key to ON.

Enter 9, depress [X].  
Enter 2000, depress [AT/TL].

Thank you Call again	
06-04-84	
20	
#-0.9	
*20.00	
10-00	1.3
13-58	

# PROGRAM VERIFICATION

## DEPARTMENT STATUS & LG, % PRESET RATE READ

Control Lock: X  
Clerk Key to ON.

Enter 1, depress **[ST]**.

Thank you  
Call again

06-04-84  
2333333

	X				
1	1	3			
2	0	4			
		6			
	10.	%+			
	10.5	%-			
	14-0022				
	14-04				

Date

Register No.

Listing Capacity

Common LC for All Depts.

%+ Preset Price 10%

%- Preset Price 10.5%

Clerk ID / Consecutive No.

Current Time

Tax Status

Dept. No.

0: Non-taxable  
1: Tax1 Taxable  
2: Tax2 Taxable  
3: Tax1 & Tax2 Taxable

## PLU TABLE READ

Control Lock: X  
Clerk Key to ON.

Enter 3, depress **[ST]**.

Thank you  
Call again

06-04-84  
2333333

	X				
05	1	*	1.00	@	
11	2	*	12.34	@	
30	2	*	10.00	@	
	14-0023				
	14-04				

Preset Price

Linked Dept No.

PLU Code

TAX CALCULATION TEST

Control Lock: X  
Clerk Key to ON.

|AMOUNT TO TEST| → |TXBL TL|

Repeat this operation,  
alternating the amount,  
until the tax table is  
found to be correct.

|  
Amount  
entered

|  
Tax due  
(Tax 1 and Tax 2  
consolidated)

└── displayed ─┘  
(No print will occur.)

# PAPER ROLL REPLACEMENT AND OTHER MAINTENANCE

## MANUAL DRAWER RELEASE AND LOCK

Fig.1

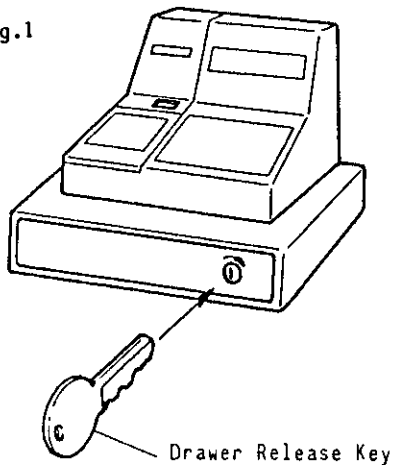

### ■ Releasing

The drawer opens automatically when a registration is made. In the event of a power failure or other troubles the drawer can be opened in the following manner.

- 1) Insert the Drawer Release Key into the drawer release lock and turn the key 45 degrees clockwise. The drawer will now open. (Fig.1)
- 2) The Drawer Release Key can be taken out by returning it to the original position.
- 3) When the drawer is closed, it is automatically locked and will not open without the Drawer Release Key.

Fig.2

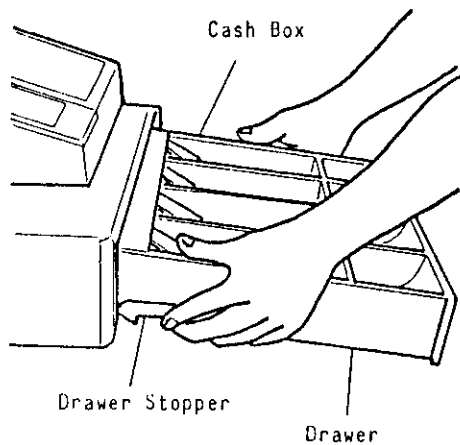

### ■ Removing the Drawer

- 1) To remove the drawer, lift it up by the stoppers attached on both sides and pull it out. (Fig.2)
- 2) When installing the drawer, the fit its rollers onto the rails of the register and push it all the way in. (Fig.2) The coin case can be removed from the drawer, by lifting it up at the front.

## CDC (Cash Drawer Cover) LOCK

### ■ Locking

Push the Cash Drawer Cover to the drawer-end plate so that the arrow parts of the cover go under and the rest parts go over the plate. (Fig.6)

Press the cover lightly, insert the key into the key-hole on the cover, and turn clockwise. Now the cover is locked.

Fig. 6

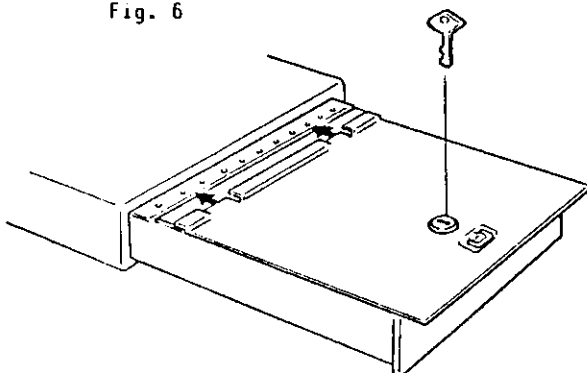

### ■ Opening

Release the lock by the key, and lift up the cover tip.

Fig. 8

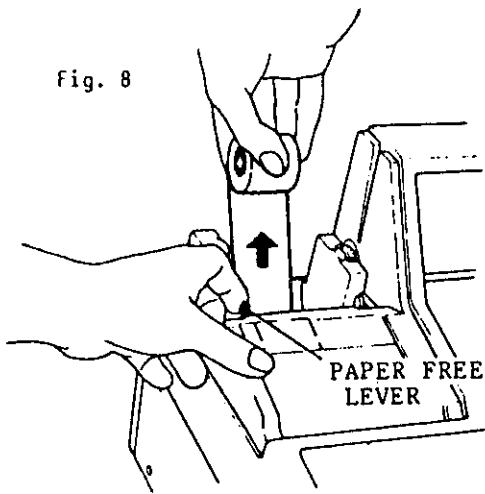

#### REPLACING THE RECEIPT OR JOURNAL ROLL

When coloured paper comes to appear, this indicates that the existing paper is near the end. In this case, replace the paper roll with new one immediately.

- 1) Open the Paper Cover.
- 2) While pulling the Paper Free Lever towards you, remove the used-up roll upwards. (Fig.8)

To remove the wound-up journal paper roll from the journal receiving shaft, pull the wound-up paper sideways.

Fig. 9

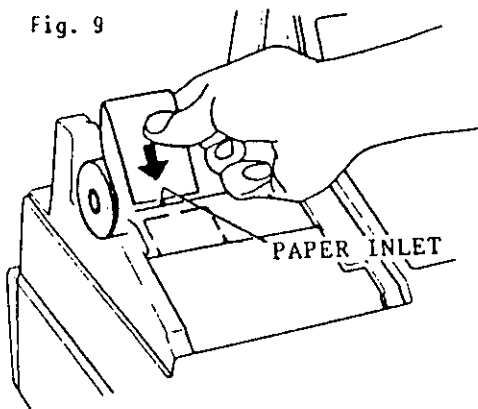

- 3) Install the new paper roll as illustrated. (Fig.9)

- 4) Insert the folded paper end into the paper inlet while depressing the **[RF]** (for receipt) or **[JF]** (for journal) key. When the paper end comes out of paper outlet, release pressure from the key.

In installing the journal paper, wind the paper on the Journal Receiving Shaft two or three turns, then set it in position.



## REPLACING THE INK ROLL

When the receipt and journal paper print becomes too light to read, replace the Ink Roll in the following manner.

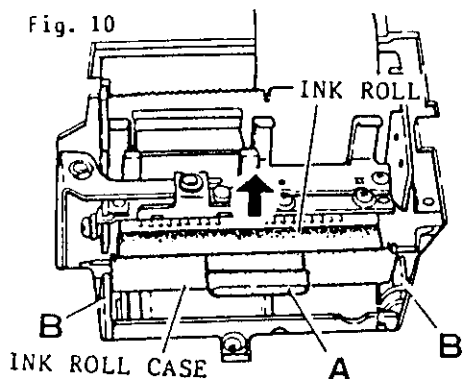

- 1) Turn the Control Lock to the "LOCK" position and remove the Ink Roll Case "A" part upwards together with the Ink Roll. (Fig.10)
- 2) To install the new Ink Roll, turn the Ink Holder "B" about 1 cm to the front and set the new roll in position.

## REPLENISHING INK TO THE STORE MESSAGE STAMP

When the store message is printed too lightly, replenish ink in the following manner. (Fig.11)

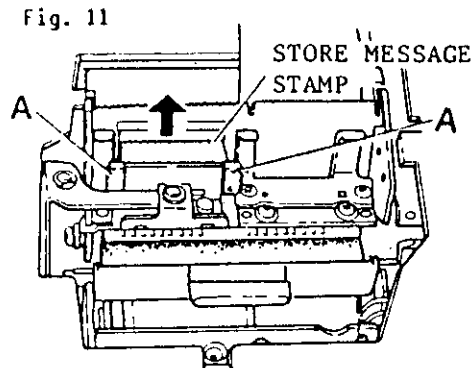

- 1) Pull the section "A" upwards and remove the stamp with the case.
- 2) Apply ink to the replenishment pad at the back of the store message stamp. The amount of refilling should be adjusted according to the density of the printed message, but the limit of 2 cc should not be exceeded. (The supplied ink bottle contains 5 cc of ink).

## SPECIFICATIONS

SIZE ..... 460mm(width) x 400mm(depth) x 329mm(height)

WEIGHT ..... 16.5kg

POWER REQUIRED ..... AC 117V 60Hz

POWER CONSUMED ..... 0.11A when not operating, 0.3A when operating

SIZE OF RECEIPT AND JOURNAL TAPE  
..... 38mm(width) x 70mm(diameter)

AMBIENT TEMPERATURE ..... 0°C ~ 40°C, 15% ~ 90% (Relative Humidity)

**NOTE:** A liquid crystal is used as the display indicator in this model. Due to the properties of liquid crystals, the entire surface of the display will become too dark to read if the ambient temperature is too high. However, in such cases when the temperature decreases, the display will return to the normal state. For this reason, please avoid exposing the unit to extremely high temperatures. The appropriate range of temperature for use is between 0°C and 40°C.



